

Understanding Motion Simulation

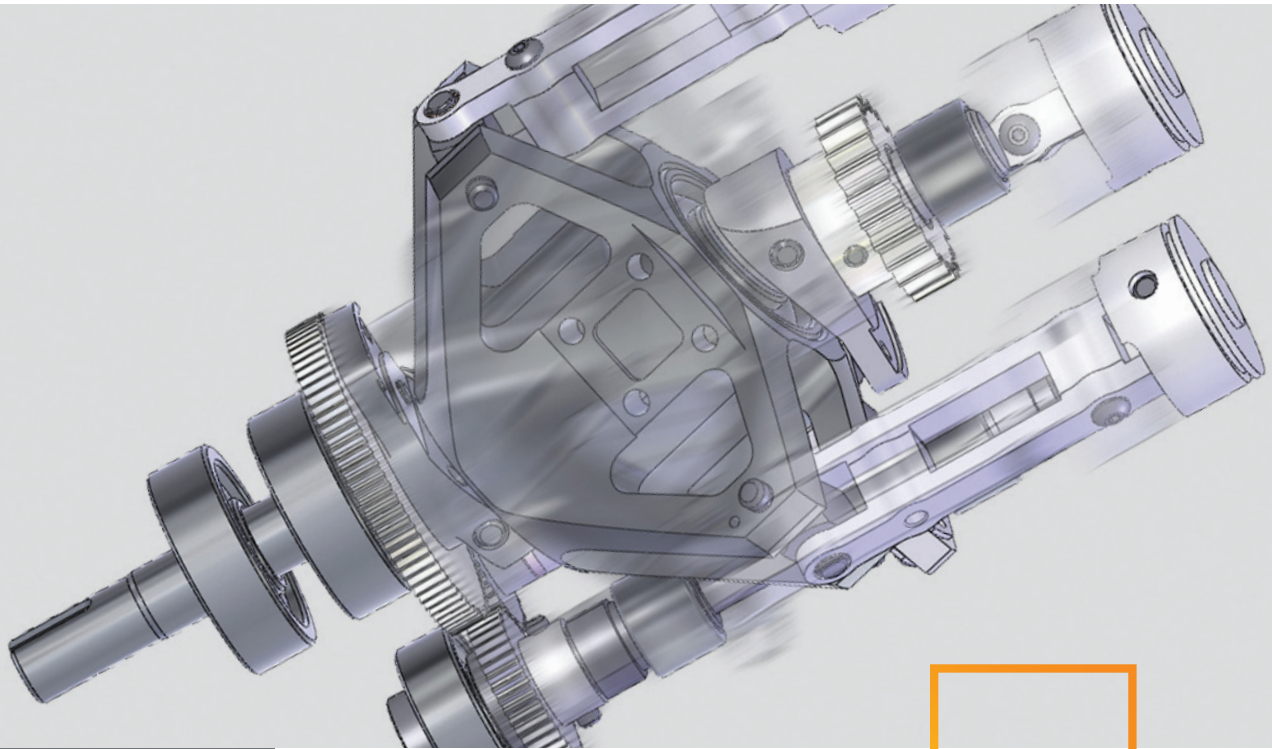

SUMMARY

What is motion simulation? What problems can it solve? How can it benefit the product design process? This paper addresses some of these issues and looks at sample problems that motion simulation can solve. It also presents real-life applications of motion simulation used as a CAE design tool.

Motion simulation provides complete, quantitative information about the kinematics—including position, velocity, and acceleration, and the dynamics—including joint reactions, inertial forces, and power requirements, of all the components of a moving mechanism.

Introduction

Since the 1980s, when computer-aided engineering (CAE) methods first became available in design engineering, finite element analysis (FEA) became the first widely adopted simulation tool. Over the years, it has helped design engineers study the structural performance of new products, and replace many time-consuming, costly prototypes with inexpensive computer simulations run on CAD models.

Today, because of the growing complexity of mechanical products and increasingly fierce competition to bring new designs to market faster, engineers feel mounting pressure to extend the scope of simulation beyond FEA. Along with simulating structural performance with FEA, engineers also need to determine the kinematics and dynamics of new products before the building of physical prototypes.

Motion simulation—also known as rigid body dynamics—offers a simulation approach to solving those issues. Its use is growing fast, and as it does, design engineers want to know more about it, asking: What is it? What problems can it solve? How can it benefit the product design process?

Motion simulation for mechanism analysis and synthesis

Suppose an engineer is designing an elliptic trammel meant for tracing different ellipses. When he has defined mates in the CAD assembly, he can animate the model to review how the components of the mechanism move (Figure 1). Although assembly animation can show the relative motion of assembly components, the speed of motion is irrelevant and timing is arbitrary. To find velocities, accelerations, joint reactions, power requirements, etc., the designer needs a more powerful tool. This is where motion simulation comes in.

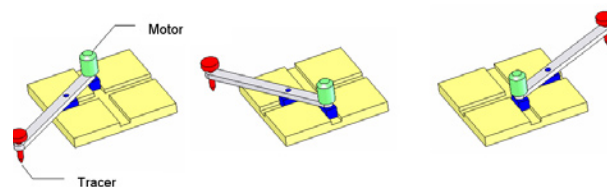

FIGURE 1: VARIOUS POSITIONS OF ELLIPTIC TRAMMEL SIMULATED USING CAD ANIMATOR

Motion simulation provides complete, quantitative information about the kinematics—including position, velocity, and acceleration, and the dynamics—including joint reactions, inertial forces, and power requirements, of all the components of a moving mechanism. Often of great additional importance, the results of motion simulation can be obtained virtually at no additional time expense, because everything needed to perform motion simulation has been defined in the CAD assembly model already, and just needs to be transferred to the motion simulation program.

The motion simulation program uses material properties from the CAD parts to define inertial properties of the mechanism components, and translates CAD assembly mating conditions into kinematic joints.

In the case of the elliptic trammel described above, the designer needs only to decide the speed of the motor, the points to be traced, and the motion results he wishes to see. The program does everything else automatically, without the user's intervention. The motion simulation program uses material properties from the CAD parts to define inertial properties of mechanism components, and translates CAD assembly mating conditions into kinematic joints. It then automatically formulates equations that describe the mechanism motion.

Unlike flexible structures studied with FEA, mechanisms are represented as assemblies of rigid components and have few degrees of freedom. A numerical solver solves the equations of motion very quickly, and results include full information about displacements, velocities, accelerations, joint reactions, and inertial loads of all the mechanism components, as well as the power necessary to sustain the motion (Figure 2).

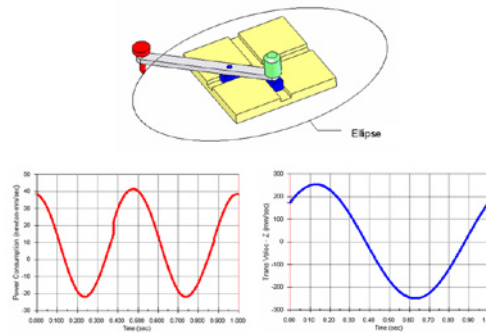

FIGURE 2: LINEAR VELOCITY AND MOTOR POWER REQUIREMENT CALCULATED BY MOTION SIMULATOR

A simulation of the motion of the inverted slider mechanism shown in Figure 3 presents an exercise commonly found in textbooks on the kinematics of machines. Here, the objective is to find the angular speed and the acceleration of the rocking arm, while the crank rotates at a constant speed. Several analytical methods can solve the problem, and the complex numbers method is perhaps the most frequently used by students. However, solving such a problem “by hand” requires intensive calculations, and even with the help of computerized spreadsheets, it may take a few hours to construct velocity and acceleration plots. Then, if the geometry of the slider changes, the whole thing has to be repeated—making this an interesting assignment for undergraduate students but completely impractical in real life product development. Motion simulation software makes it possible to simulate the motion of the inverted slider practically instantly, using data already present in the CAD assembly model.

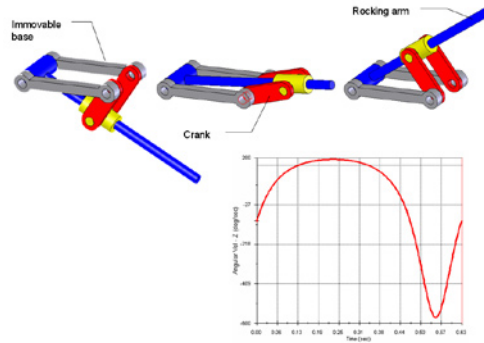

FIGURE 3: SIMULATION OF AN INVERTED SLIDER MECHANISM TO CALCULATE ANGULAR VELOCITY OF ROCKING ARM

Motion simulation conducts interference checks in real time, and provides the exact spatial and time positions of all mechanism components as well as the exact interfering volumes.

Motion simulation also checks for interferences, and this is a very different process from the interference checking available with CAD assembly animation. Motion simulation conducts interference checks in real time, and provides the exact spatial and time positions of all mechanism components as well as the exact interfering volumes. Even more, when the geometry changes, as shown in the quick return mechanism in Figure 4, the software updates all results in seconds. Each and every result pertaining to motion may be presented graphically or tabulated in any desired format.

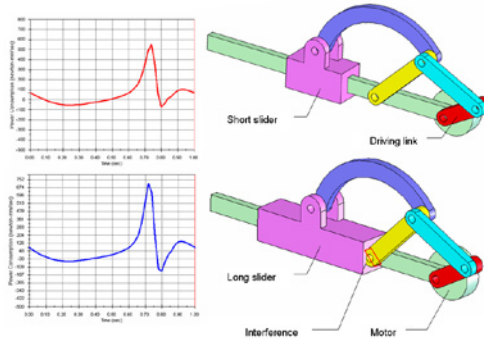

FIGURE 4: USERS CAN EASILY DETECT AND CORRECT INTERFERENCE BETWEEN SLIDER AND DRIVEN LINK.

Engineers can represent simple mechanisms such as the elliptic trammel or inverted slider described above as 2D mechanisms. Although these are difficult and time-consuming to analyze by hand, they do possess analytical solution methods. However, 3D mechanisms, even simple mechanisms such as that shown in Figure 5, have no established method of analytical solution. But motion simulation can solve the problem easily in seconds, because it is designed to handle mechanisms of any and every complexity, both 2D and 3D. The mechanism may contain a large number of rigid links, springs, dampers, and contact pairs with virtually no penalty in solution time. For example, the motions of the front-end suspension of the snowmobile in Figure 6, exercise machine in Figure 7, or CD drive in Figure 8, may be simulated with the same ease as that of the inverted slider.



FIGURE 5: A SIMPLE 3D MECHANISM IS VERY DIFFICULT TO ANALYZE “BY HAND” BUT PRESENTS NO PROBLEMS FOR MOTION SIMULATION.

In addition to mechanism analysis, product developers can also use motion simulation for mechanism synthesis by converting trajectories of motion into CAD geometry.



FIGURE 6: A FRONT-END SUSPENSION OF A SNOWMOBILE CONSISTS OF NUMEROUS LINKS INCLUDING SPRINGS AND DAMPERS.

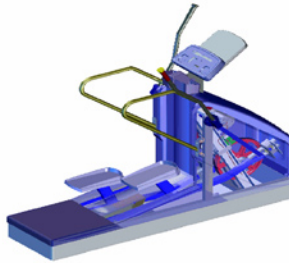

FIGURE 7: AN EXERCISE MACHINE DESIGN BENEFITS FROM MOTION SIMULATION USED TO OPTIMIZE THE STEPS' MOTION TRAJECTORIES AND CALCULATE THE POWER GENERATED BY THE USER.

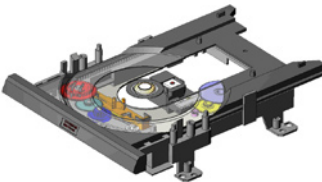

FIGURE 8: A CD DRIVE IS A COMPLEX MECHANISM, YET EASILY ANALYZED BY MOTION SIMULATION.

In addition to mechanism analysis, product developers can also use motion simulation for mechanism synthesis by converting trajectories of motion into CAD geometry, and using it to create a new part geometry. Figure 9 shows a sample problem. This design features a cam that should move a slider along a guide rail, and uses motion simulation to generate a profile of that cam. The user expresses the desired slider position as a function of time and traces the slider movement on the rotating blank cam (the round plate). Then he converts the trace path into CAD geometry to create the cam profile shown in Figure 10.

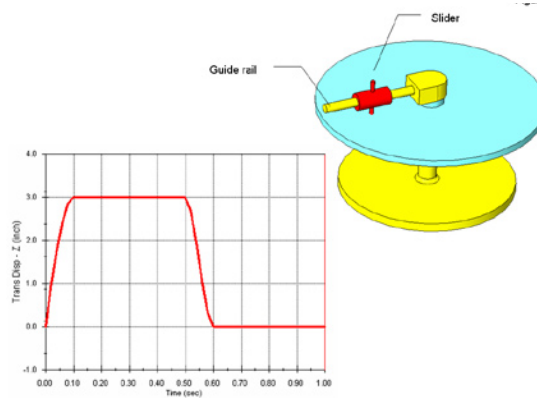

FIGURE 9: A DISPLACEMENT FUNCTION IS APPLIED TO MAKE THE SLIDER TRAVEL ALONG THE GUIDE RAIL.

Designers can also use trajectories of motion to verify the motion of an industrial robot.

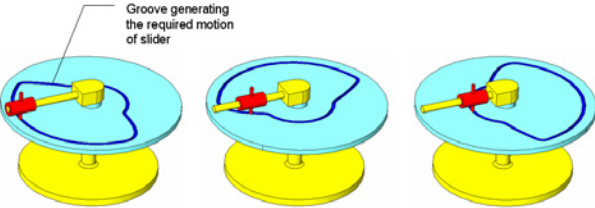

FIGURE 10: TRAVEL OF THE SLIDER IS TRACED ON THE ROTATING ROUND PLATE TO CREATE A CAM PROFILE, ILLUSTRATED HERE WITH A GROOVE CUT IN THE PLATE.

Designers can also use trajectories of motion, for example, to verify the motion of an industrial robot, such as that shown in Figure 11, and test the toolpath to obtain information necessary when selecting the size of robot needed, and to establish power requirements—all without the need for any physical tests.

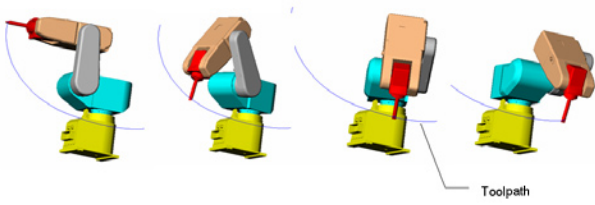

FIGURE 11: SIMULATED MOVEMENT OF AN INDUSTRIAL ROBOT THROUGH SEVERAL POSITIONS MAKES IT POSSIBLE TO CREATE A TOOLPATH WITHOUT ANY PHYSICAL TESTS.

Another important application for motion simulation relates to motion induced by collisions between moving bodies. Even though certain assumptions must be made about the elasticity of such impacting bodies, motion simulation produces accurate results for mechanisms with components that may experience only temporary contact, as shown in Figure 12.

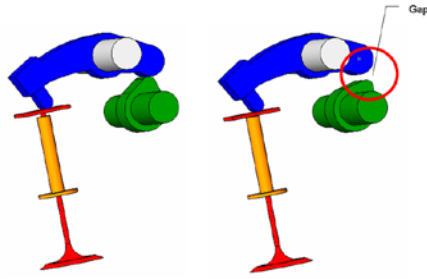

FIGURE 12: IMPACT AND CONTACT CAN BE SIMULATED IN MOTION SIMULATION, FOR EXAMPLE, TO STUDY A GAP THAT MAY FORM BETWEEN A CAM AND A FOLLOWER (ROCKER) IN A VALVE LIFTING MECHANISM.

To understand how motion simulation and FEA work together in mechanism simulation, it helps to understand the fundamental assumptions on which each tool is based.

Using motion simulation along with FEA

To understand how motion simulation and FEA work together in mechanism simulation, it helps to understand the fundamental assumptions on which each tool is based.

FEA is a numerical technique for structural analysis that has come to be the dominant CAE approach for studying structures. It can analyze the behavior of any firmly supported elastic object, such as the bracket shown in Figure 13. By elastic we mean the object is deformable. With the application of a static load, the bracket acquires a new, deformed shape, and then remains motionless. The application of a dynamic load causes the bracket to vibrate about the position of equilibrium. FEA can study displacements, strains, stresses, and vibration of the bracket under static or dynamic load.

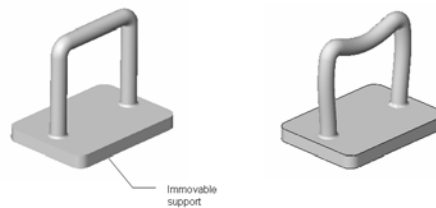

FIGURE 13: A FIRMLY SUPPORTED BRACKET CAN'T MOVE WITHOUT DEFORMATION.

In contrast, a partially supported object, such as the flywheel hinged on the bracket (Figure 14) can rotate without having to deform. The flywheel can move as a rigid body, which classifies the device as a mechanism rather than as a structure. To study the motion of the flywheel, we use motion simulation. Strains and stresses cannot be calculated when treating the flywheel as a rigid body. (For more information, please see Appendix 1.)

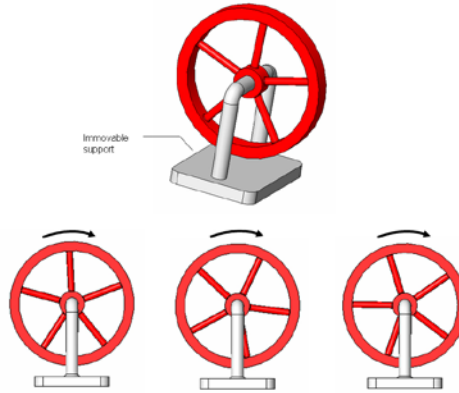

FIGURE 14: A FLYWHEEL SPINS AS A RIGID BODY ABOUT THE HINGE JOINING IT TO THE BASE (TOP). THE PRESENCE OF RIGID BODY MOTION (BOTTOM) CLASSIFIES THIS DEVICE AS A MECHANISM.

The difference between a structure and a mechanism may not be obvious at first sight.

The difference between a structure and a mechanism may not be obvious at first sight, as the two devices in Figure 15 illustrate. Both have swing arms connected to an immovable base by a hinge. The one on the right has a spring connecting the arm to the base. The device without the spring is the mechanism, because the swing arm can rotate freely. Whether it spins about the hinge or oscillates about the position of equilibrium, no part of the device has to deform during the arm movement. The arm shows rigid body motion, classifying the device on the left as a mechanism. Designers can study its motion with motion simulation.

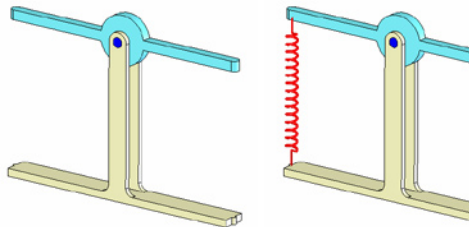

FIGURE 15: THE SWING ARM ON THE LEFT CAN MOVE WITHOUT DEFORMATION; THUS IT'S A MECHANISM. ANY MOVEMENT IN THE ARM ON THE RIGHT IS ACCOMPANIED BY DEFORMATION OF THE SPRING; THIS MEANS IT'S A STRUCTURE.

The addition of the spring changes the nature of the device, because now the arm cannot move without deforming the spring. The only possible form of continuous arm motion is vibration about the position of equilibrium. Deformation in the spring accompanies arm motion and this classifies the device on the right as a structure. FEA can analyze the arm vibration, and, if desired, can go on to calculate strains and stresses in the spring and in other components which are treated as elastic bodies. (Please see Appendix 2 for further information about the differences between motion simulation and FEA.)

If, having completed motion simulation studies, the design engineer wants to perform deformation and/or stress analysis on any mechanism component, the chosen component needs to be presented to FEA for structural analysis.

Motion simulation results supply the input data, consisting of joint reactions and inertial forces that act upon each link of the mechanism, required for structural analysis conducted with FEA. Motion simulation always calculates these factors, whether or not followed by FEA. Joint reactions and inertial forces are, by definition, in balance, and mechanism components subjected to a balanced set of loads can be submitted to FEA and treated by the analysis program as if they were structures.

“Coupled” simulation offers the advantage of defining FEA loads automatically, eliminating guesswork and possible errors common to manual setup.

While the engineer can transfer that data from motion simulation to FEA manually, he can be sure of the best results if the motion simulation software can export results to FEA automatically. When used in such a way, motion simulation and FEA perform what’s termed “coupled” simulation. This offers the advantage of defining FEA loads automatically, eliminating guesswork and possible errors common to manual setup.

The example of a crank mechanism problem shown in Figure 16 demonstrates the coupled simulation. Here, the design engineer wants to find the maximum stresses in the connecting rod.

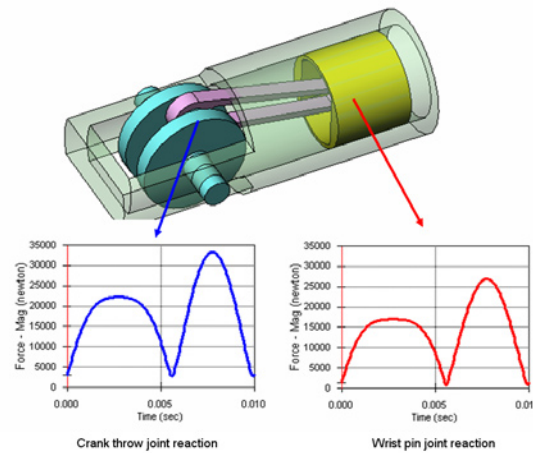

FIGURE 16: MOTION SIMULATION FINDS REACTIONS ON BOTH ENDS OF THE CONNECTING ROD. INERTIAL FORCES ACTING ON THE ROD ARE ALSO CALCULATED.

The procedure for combining the use of motion simulation and FEA is:

1. Use motion simulation to find displacements, velocities, accelerations, joint reactions, and inertial forces acting on all components within the range of motion selected for study. In this step, all the mechanism links are treated as rigid bodies. The plots in Figure 16 show connecting rod joint reactions during one full turn of a crank.

Analysts most often look for the highest reactions because the analysis under the maximum loads shows the maximum stresses experienced.

2. Find the mechanism position that corresponds to the highest reaction loads on the joints of the connecting rod. Analysts most often look for the highest reactions because the analysis under the maximum loads shows the maximum stresses experienced by the connecting rod. If desired, however, any number of positions—see Figure 17—may be selected for analysis.

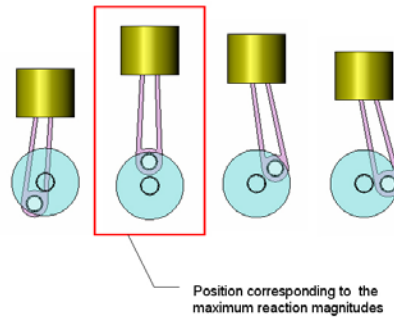

FIGURE 17: FORCES—REACTIONS ON BOTH ENDS AND INERTIAL FORCES—ACTING ON THE CONNECTING ROD MAY BE DETERMINED FOR ANY NUMBER OF CRANK SHAFT MECHANISM POSITIONS.

3. Transfer those reaction loads, along with the inertial load from the CAD assembly, to the connecting-rod CAD part model.
4. The loads that act on the connecting rod isolated from assembly consist of joint reactions and inertial forces, as shown in Figure 18. According to the d’Alambert principle, these loads are in balance, making it possible to treat the connecting rod as a structure under a static load.

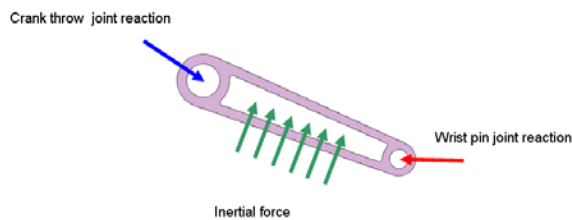

FIGURE 18: ACCORDING TO THE D’ALAMBERT PRINCIPLE, JOINT REACTIONS ARE IN BALANCE WITH INERTIAL FORCES.

5. A connecting rod subjected to a balanced set of static loads is assigned elastic material properties and submitted to FEA for structural static analysis. FEA performs structural analysis to find deformations, strains, and stresses (Figure 19).

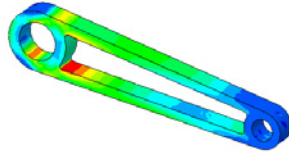

FIGURE 19: THE CONNECTING ROD IS PRESENTED TO FEA AS A STRUCTURE SO THAT STRESSES CAN BE CALCULATED.

Both motion simulation and FEA use a CAD assembly model as a prerequisite for analysis.

Motion simulation and test

Motion simulation is capable of importing time-history data from a test. This way a motion of an existing mechanism can be easily reproduced and fully analyzed including all joint reactions, inertial effects, power consumption, and more. using inexpensive computer models rather than time-consuming and expensive tests. In a similar way a mechanism can be analyzed under input defined by an analytical function.

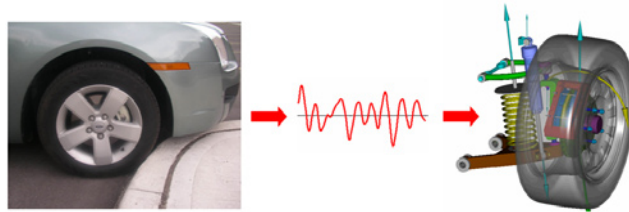

FIGURE 20: TEST DATA FOR MOTION OF THE CONTROL ARM IS USED AS AN INPUT TO MOVE THE SUSPENSION MODEL IN MOTION SIMULATION.

For example, in the case of a car suspension, pictured in Figure 20, motion simulation answers such typical questions as: How soon after a wheel hits a curb will the oscillation caused to the suspension die out? What is the required damping in the strut? What stresses are induced in the control arms and its bushings?

Integrated CAD, motion simulation, and FEA

Both motion simulation and FEA use a CAD assembly model as a prerequisite for analysis. A common, integrated environment for all three tools facilitates the data exchange among CAD, motion simulation, and FEA. Integration avoids cumbersome data transfer via neutral file formats, typical to standalone applications. In addition, the use of motion simulation integrated with CAD, and not interfaced with it, greatly reduces the effort required to set up motion simulation models.

As discussed above, material properties and CAD assembly mates can be “re-used” when creating a motion simulation model. Motion trajectories, which are results of motion simulation, can be turned back into CAD geometry. This, however, is only possible in an integrated software environment. Additionally,

integration with CAD eliminates a need for maintaining a database for motion simulation models by storing the simulation model data and the results of simulations together with the CAD assembly model. Last but not least, any CAD changes are fully associative with motion simulation as well as with FEA.

The SolidWorks® CAD program together with SolidWorks Simulation (FEA) and SolidWorks Motion (motion simulation) as add-ins represents the state of the art in integrated simulation tools. Full integration has been made possible because SolidWorks, SolidWorks Simulation, and SolidWorks Motion are all native Windows® applications. All were developed specifically for the Windows operating system and not just ported from other operating systems. Full compatibility with Windows also assures compatibility with other applications running in Windows.

The SolidWorks CAD program together with SolidWorks Simulation (FEA) and SolidWorks Motion (motion simulation) as add-ins represents the state of the art in integrated simulation tools.

SolidWorks Simulation, a leading FEA program, has long proven itself very valuable as a product design tool working closely with CAD, as shown in Figure 21. The addition of SolidWorks Motion now enables an even more complete simulation of new products, and helps to reduce the number of physical prototypes needed in product development (Figure 22).

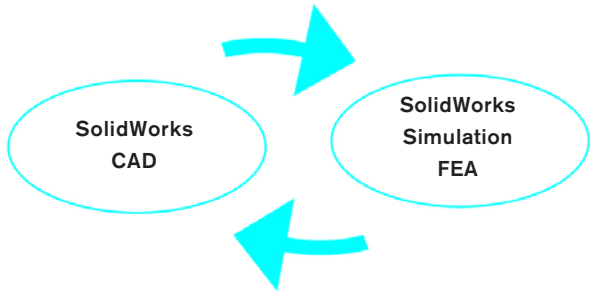

FIGURE 21: THIS DESIGN PROCESS USES CAD AND FEA AS DESIGN TOOLS.

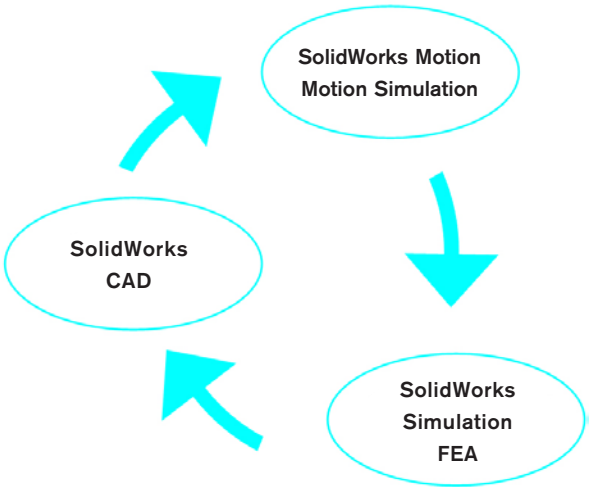

FIGURE 22: THE DESIGN PROCESS BENEFITS FROM USING MOTION SIMULATION ALONG WITH CAD AND FEA.

Real-life examples

Tigercat

Tigercat (www.tigercat.com), a leading manufacturer of such forestry equipment as skidders, forwarders, and feller-bunchers, used SolidWorks to design the feller-buncher head shown in Figure 23. The company's engineers then simulated its functions with SolidWorks Motion and SolidWorks Simulation. Tigercat reports that simulation of the motion, dynamics, and stresses of this complex mechanism reduced empirical testing requirements to a single prototype. Prototype testing fully confirmed the simulation findings.

Simulation of the motion, dynamics, and stresses of this complex mechanism reduced empirical testing requirements to a single prototype.



FIGURE 23: THE FELLING HEAD OF A FELLER-BUNCHER BY TIGERCAT, OF BRANDFORD, ONTARIO WAS DESIGNED IN SOLIDWORKS AND SIMULATED IN SOLIDWORKS MOTION AND SOLIDWORKS SIMULATION.

FANUC Robotics America Inc.

FANUC Robotics (www.fanucrobotics.com) manufactures a widely used robotic product line that helps customers in many different industries optimize labor, lower costs, improve quality, and minimize waste in their manufacturing operations. For its customers to gain those benefits, FANUC offers many different sizes of robotic tools, as indicated in Figure 24, and the customers need to select the right size for their specific applications. They do so by analyzing robot performance along specified toolpaths—and simulation with SolidWorks Motion makes such analysis and selection much easier.

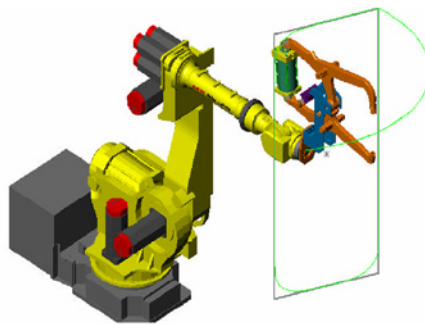

FIGURE 24: THIS INDUSTRIAL ROBOT WAS CREATED BY FANUC ROBOTICS AMERICA, OF ROCHESTER HILLS, MICHIGAN.

Through the use of SolidWorks and SolidWorks Motion, it realized an estimated \$45,000 in cost savings, and reduced testing time to just 10 percent of its former build-and-test process.

Ward Machine Tool

Ward Machine Tool (www.wardcnc.com) designs and manufactures custom lathe chucks for aluminum wheels, rotary actuators, and specialty machining fixtures. Ward's engineers design custom products that have never been built before, and find simulation to be indispensable for verifying whether or not a new design will work—before sending it to be manufactured. For example, the company developed and tested the dual-actuated/multirange aluminum wheel lathe chuck shown in Figure 25 without testing any physical prototypes. Ward reports that through the use of SolidWorks and SolidWorks Motion, it realized an estimated \$45,000 in cost savings, and reduced testing time to just 10 percent of its former build-and-test process.

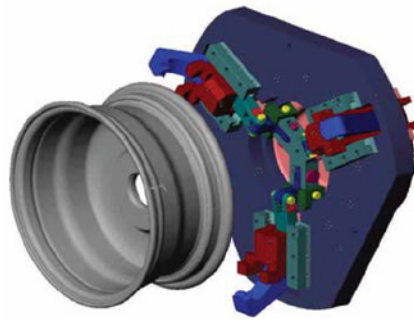

FIGURE 25: WARD MACHINE TOOL OF FOWLERVILLE, MICHIGAN DESIGNED AND SIMULATED THE LATHE CHUCK.

Synchroness

Synchroness (www.synchroness.com) is a product development bureau that works closely with customers to develop products that vary from exercise equipment to laser systems. Synchroness used both SolidWorks Motion and SolidWorks Simulation to optimize the four-bar linkage system for a scissors lift shown in Figure 26. According to Synchroness, the engineering team conducted the motion simulation with little training and no down time. Synchroness says that the use of simulation made it possible to conduct quick design iterations, and provided a great visualization tool for the customer—so that overall, it was vital to the successful design solution.

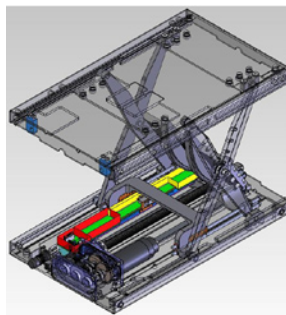

FIGURE 26: THIS LIFTING PLATFORM WAS DESIGNED BY SYNCRONESS, OF WESTMINSTER, COLORADO USING SOLIDWORKS, SOLIDWORKS MOTION, AND SOLIDWORKS SIMULATION AS DESIGN TOOLS.

APPENDIX 1: Rigid Body Motion

If an object can move without undergoing deformation, we describe it as having rigid body motion, or rigid body mode. The presence of rigid body motion(s) classifies the object as a mechanism.

Figure 27 shows a ball joint. The base is immovable. Such a joint has three rigid body motions because it can move in three independent directions, or three rotations, without deformation. Three independent variables, also called degrees of freedom, describe the position of this mechanism.

The presence of rigid body motion(s) classifies the object as a mechanism.

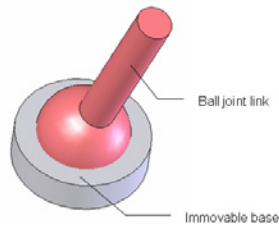

FIGURE 27: THE BALL JOINT MECHANISM SHOWN IS A KINEMATIC PAIR WITH THREE RIGID BODY MOTIONS.

Figure 28 illustrates a plate sliding on an immovable base plate. This mechanism also has three rigid body motions because the sliding plate can translate in two directions and can rotate in one direction without experiencing any deformation. Again, three degrees of freedom describe the position of the mechanism.

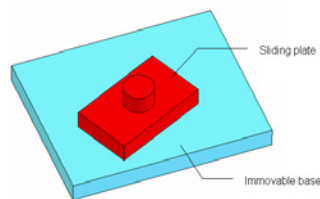

FIGURE 28: THE SLIDING PLATE MECHANISM HAS THREE RIGID BODY MOTIONS.

The four-bar linkage shown in Figure 29 has one rigid body motion. One independent variable, for example the angular position of any link, describes the position of the entire mechanism. Note that depending on the detailed hinge design, hinge pins may have local rigid body motions, that is, rotation about the pin axis and/or sliding along the pin axis.

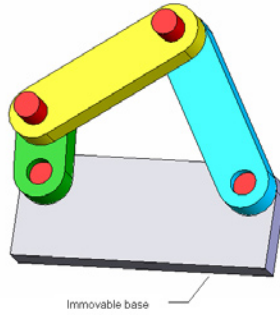

FIGURE 29: ANGULAR POSITION OF ANY LINK IN THE MECHANISM DEFINES THE POSITION OF THE ENTIRE MECHANISM. THIS MECHANISM HAS ONE RIGID BODY MOTION.

Modes of vibration require analysis with FEA rather than with motion simulation.

All three of the illustrated mechanisms may also have degrees of freedom due to motion that results from deformation. These are called “elastic modes.” In the four-bar linkage, for example, each individual link may perform a motion while also experiencing vibration. Modes of vibration require analysis with FEA rather than with motion simulation.

APPENDIX 2: Comparison of Motion Simulation and FEA

Motion simulation and FEA complement each other, and their territories may overlap, as can be seen in the table below:

Type of Problem	FEA	Motion Simulation
Analysis of structures (deformable objects)	Yes	No*
Analysis of mechanisms	No	Yes
Analysis of deformations and stresses	Yes	No
Analysis of vibration	Yes	No**
Analysis of models with rigid body motions	No***	Yes
Analyzed model must be meshed	Yes	No
Analyzed model is prepared in CAD	Yes	Yes

* Motion simulation does allow for some deformable components, such as springs and flexible joints. If the analysis studies motion involving impact, the user defines the elasticity of colliding bodies.

** Motion simulation software can analyze vibration, if the model includes elastic components such as springs. Such vibration analysis is limited to oscillation due to deformation of those elastic components, while other mechanism components (links) remain rigid.

*** With special modeling techniques, such as the addition of soft springs or inertial relief to the FEA model, rigid body motions may be eliminated artificially so that FEA can analyze structures with rigid body motions.

Conclusion

Along with simulating structural performance with FEA, engineers need to determine the kinematics and dynamics of new products before the building of physical prototypes. They also face mounting pressure to extend the scope of simulation beyond FEA. Motion simulation offers a simulation approach to solving these problems. The results of motion simulation can be obtained virtually at no additional time expense, because everything needed to perform motion simulation has been defined in the CAD assembly model already.

In addition to mechanism analysis, product developers can also use motion simulation for mechanism synthesis by converting trajectories of motion into CAD geometry, and using it to create a new part geometry. If, having completed motion simulation studies, the design engineer wants to perform deformation and/or stress analysis on any mechanism component, the chosen component needs to be presented to FEA for structural analysis. Motion simulation results supply the input data required for structural analysis conducted with FEA.

While the engineer can transfer that data from motion simulation to FEA manually, you can be sure of the best results if the motion simulation software can export results to FEA automatically. SolidWorks software offers just such a capability with its fully integrated SolidWorks Simulation and SolidWorks Motion software. Together, these SolidWorks solutions enable an even more complete simulation of new products and help reduce the number of prototypes required.



Dassault Systèmes SolidWorks Corp.
300 Baker Avenue
Concord, MA 01742 USA
Phone: 1 800 693 9000
Outside the US: +1 978 371 5011
Email: info@solidworks.com

www.solidworks.com